

Trailer Crane AHK 36



Technical Data

Permissible gross vehicle weight (t)	3.5
Max. payload (kg)	1,500 (optional 2,400)
Max. extension length (m)	34.0 (optional 36.0)
Working height up to boom (m)	22.7
Boom extendable (m)	4.9 / 8.0 / 11.1 (opt. 13.1)
Boom payload (kg)	2,400 / 1,500 / 800 / 500 / (250)
Main mast angle (degrees)	85
Boom angle (degrees)	162
Pivoting range (degrees)	endless
Hook speed (m/min)	50
Range for crane operation at 250 kg (m)	23.1 (23.5)
Range for crane operation at 500 kg (m)	16.6
Range for crane operation at 800 kg (m)	12.9
Range for crane operation at 1 t (m)	10.0
Range for crane operation at 1,5 t (m)	7.5
Range for crane operation at 2 t (m)	5.4
Range for platform operation at 250 kg (m)	15.8
Range for platform operation at 100 kg (m)	18.8
Working height in platform operation max. (m)	29.0

All rights reserved for changes. All specified values are maximum values.

The trailer crane AHK 36 scores with its well-proven advantages of the class leader that clearly surpasses all comparable trailer cranes: Extension lengths up to 36 m, loads up to 2400 kg, up to 256 different outrigger positions thanks to the Multiflex outriggers, auto-levelling, slew and boom-angle restriction as well as the Go-Home function.

Thanks to its Easy-Lock system the AHK 36 can be converted into an fully-fledged work platform in short time. New features include improved insulation and noise emission reduction by seven decibel when equipped with a petrol engine.

Böcker
MY WAY TO THE TOP

Working range crane operation

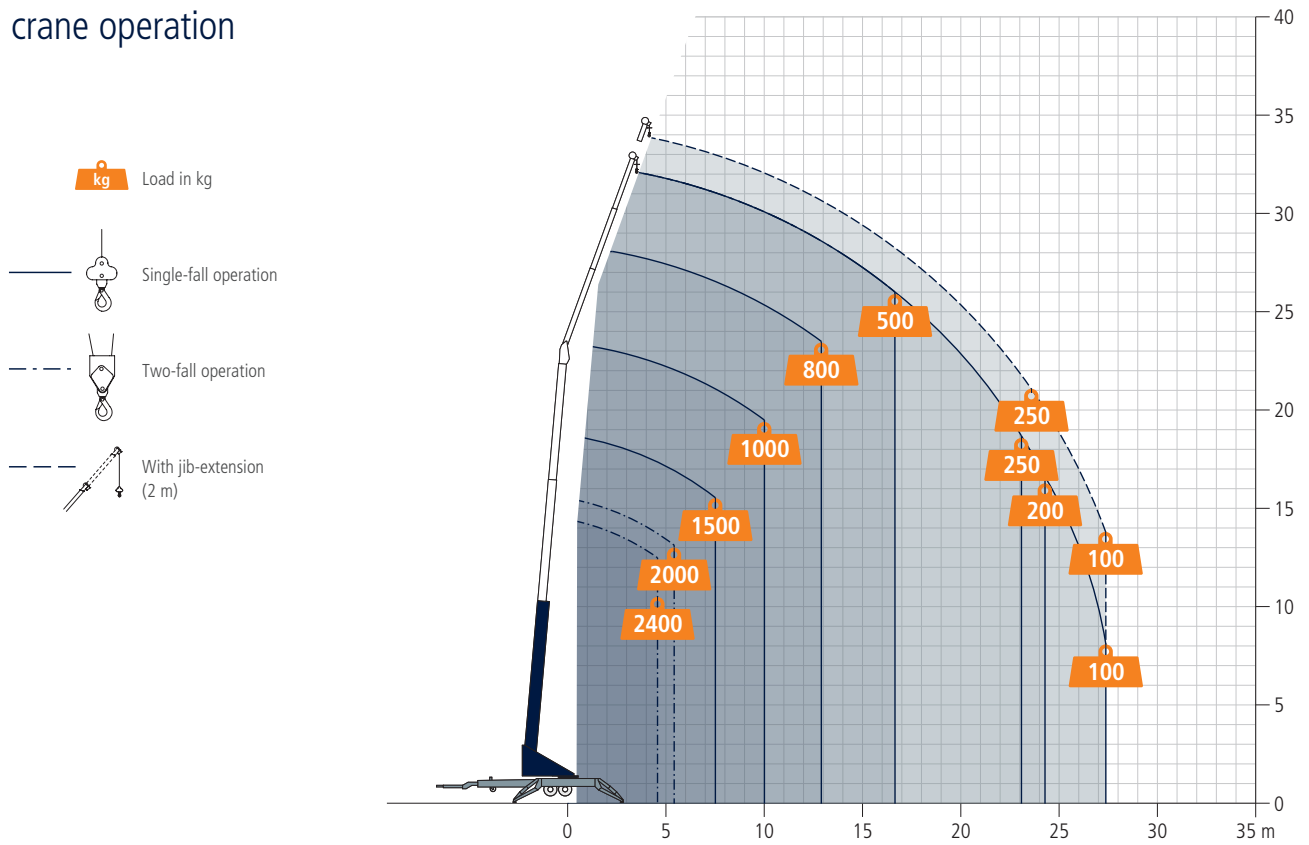

Working range platform operation

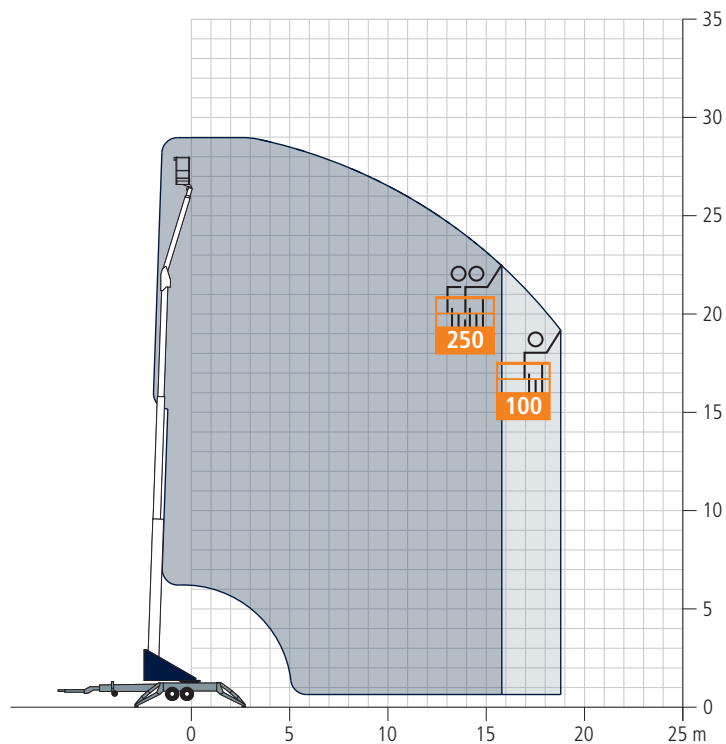

All weights are in kg.
Measurements can fluctuate slightly.

Dimensions

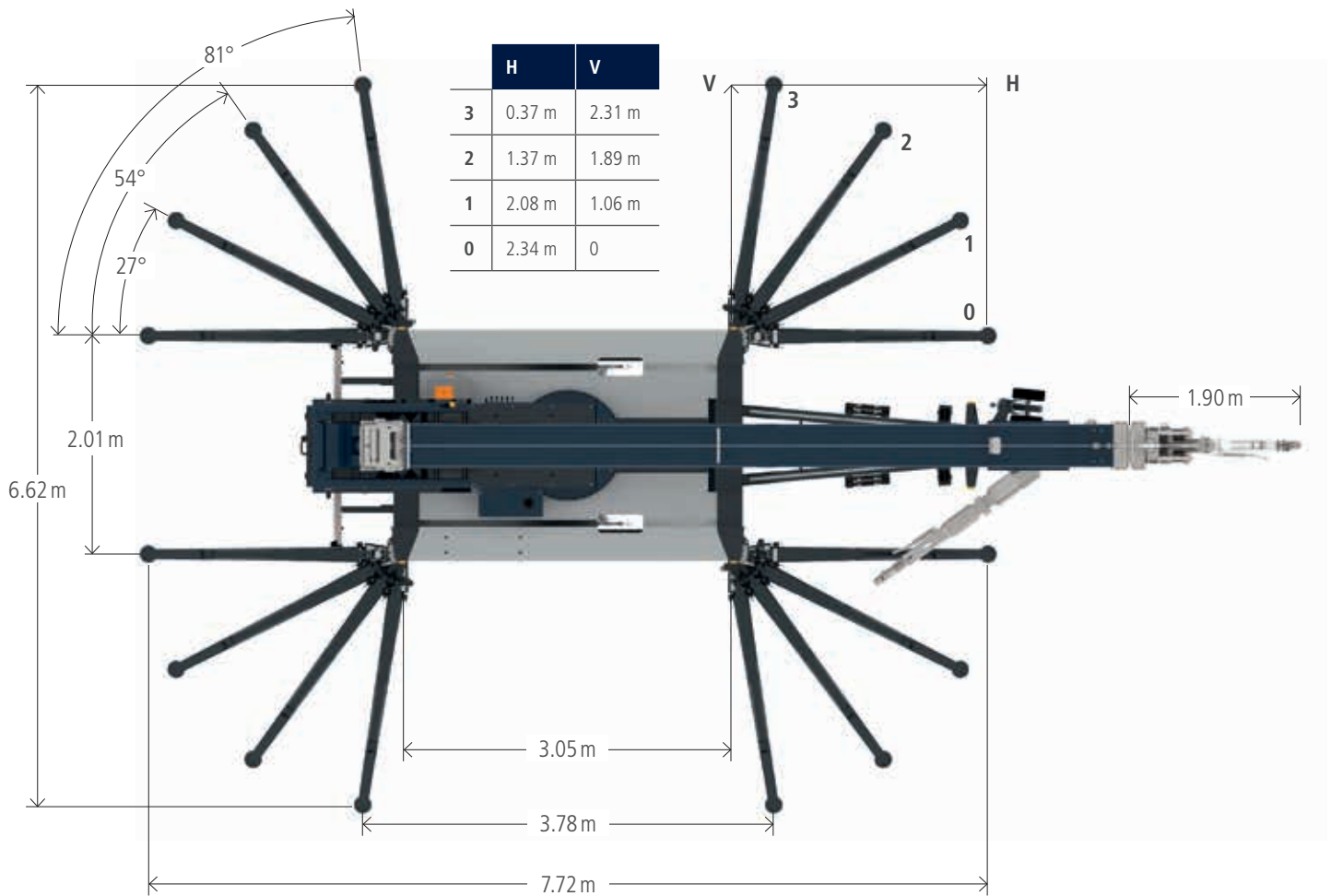

All weights are in kg.
Measurements can fluctuate slightly.

Böcker

www.boecker.de

Boecker UK Limited

Grazebrook Industrial Park
Hulbert Drive · Dudley
West Midlands UK-DY2 0XW

Fon +44 (0)1384 476580
info@boecker.co.uk